



DENER MAKİNA SAN. TİC. A.Ş

+90 352 321 13 50

Sultansazi OSB 6. sk No:12

info@dener.com

+90 352 321 13 53

38560 İncesu / KAYSERİ / TR

www.dener.com

R-2311-ER-YL-03-EN



CNC ELECTRIC SERVO BRAKE



Dener Makina was established in 1974 in Kayseri Old Industrial Zone. Since 2000, Dener Makine has focused on the production of CNC Sheet Metal Processing Machines and continues its production with a wide range of products including Guillotine Shears, Hydraulic Press Brakes, Ball Screw Press Brakes, Servo Electric Press Brakes, Plasma Cutting Machines and Fiber Laser Cutting Machines.

In 2016, the company made a significant investment by incorporating 155,000 m² factory buildings and 27,000 m² social facilities located on 1,300,000 m² of land owned by TAKSAN A.Ş. In the new period, Taksan Integrated Facilities started the production of CNC Metal Processing Machines such as Double Column Machining Centres, 5 Axis Simultaneous Machining Centres, Vertical Machining Centres, Lathes and Grinding Machines.

Dener Makina, CNC Sheet Metal Processing Machines and CNC Metal Processing Machines, with its wide range of machinery production, half a century of experience, qualified workforce and multinational R&D centre, is the first in the world by offering important investment products to the world industrial enterprises.



04	SERVO ELECTRIC PRESS BRAKE
06	WORKING SYSTEM & COMPONENTS
08	STANDARD & OPTIONAL EQUIPMENTS
12	BACK GAUGE SYSTEMS
14	CONTROLLERS
16	CLAMPING SYSTEMS
20	AIR BENDING TONNAGE CHART
21	TECHNICAL SPECIFICATIONS





* Some Optional equipments used on the machine photos

MODEL	BENDING CAPACITY (t)	BENDING LENGHT (mm)
DDM-4015	40	1530
DDM-5020	50	2040
DDM-6525	65	2550
DDM-8025	80	2550
DDM-10030	100	3050
DDM-13030	130	3050
DDM-15030	150	3050
DDM-17535	175	3570
DDM-20040	200	4080

**Pays
you
back.**

SERVO ELECTRIC PRESS BRAKE

Dener Servo Electric Press Brakes are no-hydraulic, flexible, reliable and advance bending machines. This next generation machine idea combines green-eco firendly machines with productivity, accuracy, flexibility and reliability. The new concept offers low power consuption, less maintenance, no hydraulic oil for operation.

Dener Electric Press Brakes come with an advance CNC controller, fast and accurate punch and die clamping, and a multi axis back gauge system. Operators easily make perfect sheet metal parts with very low cost.

Dener utilizes the most stringent manufacturing technologies during the production to manufacture highest quality machines. Standard Dener electric press brake come with a 3D graphical CNC controller offering simple operation, quick and easy 3D or numerical part programming easy set up of the machine, and auto calculation of the bend sequence. Optional 3D off line programming features the ability to create programs on an ofice PC then transfer to the CNC control by LAN or USB

**“EXCEED YOUR
EXPECTATIONS”**



HOW SERVO ELECTRIC PRESS BRAKE WORKS

Servo Brake pressing force by means of synchronized two servo motors that transfer the power by the help of special belt and pulleys. During the upper beam down movement, the servo motors place a tension force F on the belt that is multiplied equally in every belt segment. The force of each motor (F) creates a down force many times greater. The ram return force is derived from mechanical springs located at the side of the machine. These springs are compressed during pressing time, but recoil after completion of the bend pushing the ram to a programmed top of stroke position.

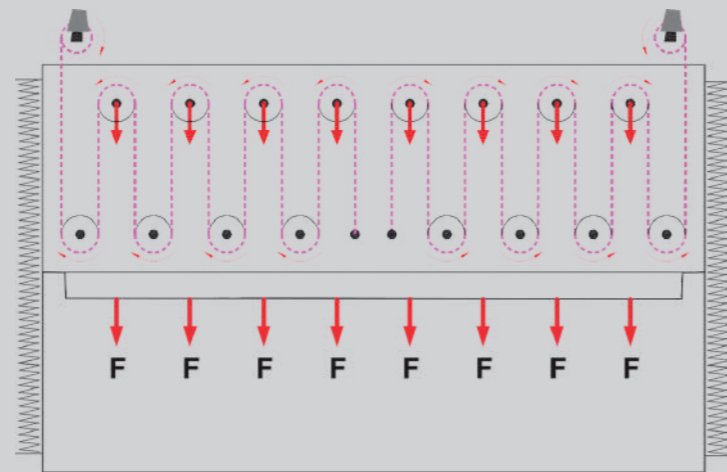
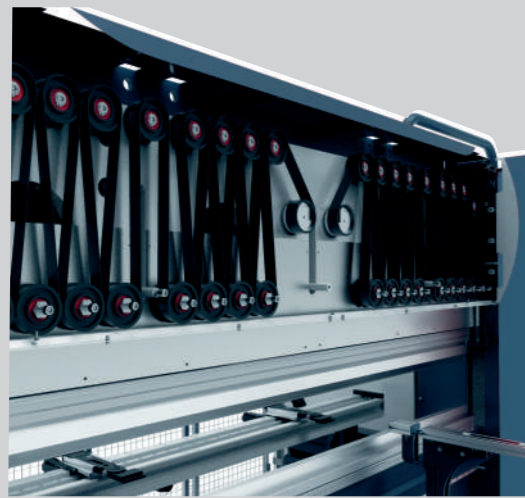

The Servo Brake has a closed O-frame system that supplies a rigid frame with no deformation under large forces. The result is better tool alignment and more accurate bends.

O-Frame Conventional Frame

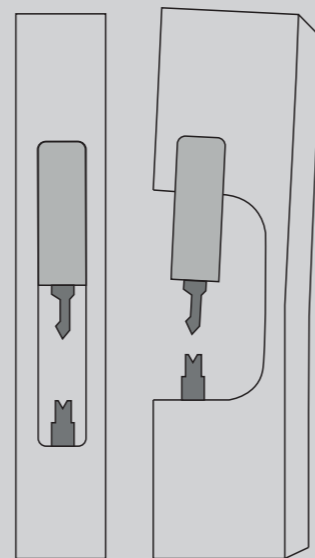

SERVO ELECTRIC PRESS BRAKE



STANDARD EQUIPMENT

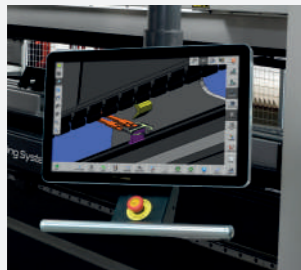

ESA S 675
Controller

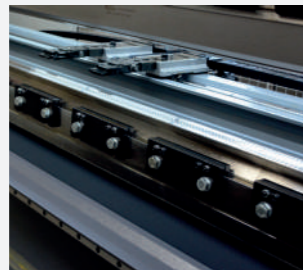

Europen Type V Die Holder



Europen Type Punch Holder



Electrical Cabinet
Cooling System



Linear Guided Front
Support Arms



X - R Type 2 Axis
Back Gauge



CE Laser Safety System



Foot Pedal with
Emergency Stop Button

OPTIONAL EQUIPMENT



Delem DA 66T-69T
Controllers



Wila Type Punch
Clamping System



Wila Type V Die
Clamping System



Crowning CNC
Adjustment



X R Z1 ve Z2
4 Axis Back Gauge



ATF Type X1 X2 R1 R2 Z1 Z2
Back Gauge



CE Confirmation with
Light Curtain



Sheet Follower



Servo Electric Press Brake provides energy saving up to 50%
Servo Electric Press Brake has %50 energy saving compared with hydraulic press brakes.



Servo Electric Press Brake is faster up to 30%
Servo Electric Press Brake is shown to be up to 30% faster than hydraulic press brake. Shorter response time one of the biggest advantages of servo electric press brake.



Servo Electric Press Brake is eco - friendly machine
Servo uses 100% electrical power instead of hydraulic oil and hydraulic components. Less pollution - best solution.



Servo Electric Press Brake provides high productivity
Servo has high acceleration, high deceleration. The quick change of the moving direction is a advantage for high productivity and efficiency. Servo has less maintenance cost.



Servo Electric Press Brake provides advanced bending
Servo is a flexible, reliable and advance bending machine. Servo Electric Press Brake combines high accuracy, flexibility and reliability. This concept offers low power consumption , less maintenance and no hydraulic oil or components for operation.



Servo Electric Press Brake works quietly
Servo working system has no noise and provides silent working conditions.

NO

NOISE
HYDRAULIC OIL
HYDRAULIC FILTER
HYDRAULIC SEALS
VALVES
CYLINDERS
DWELL TIMES

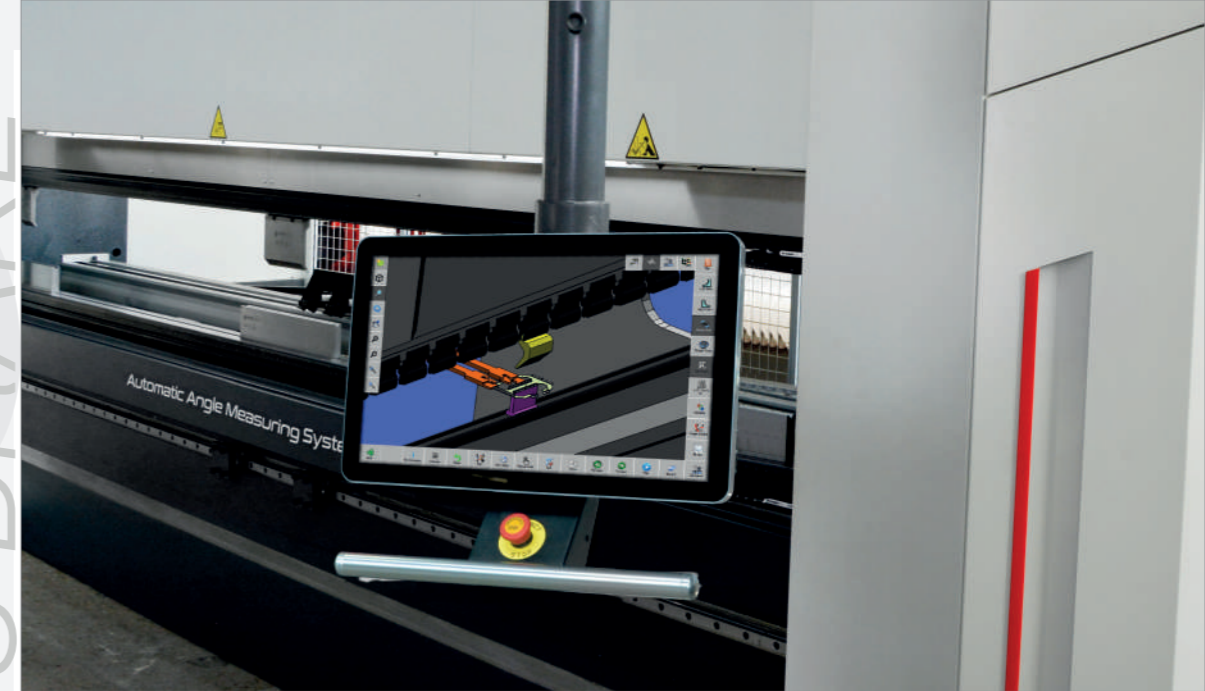

* Some Optional equipments used on the machine photos

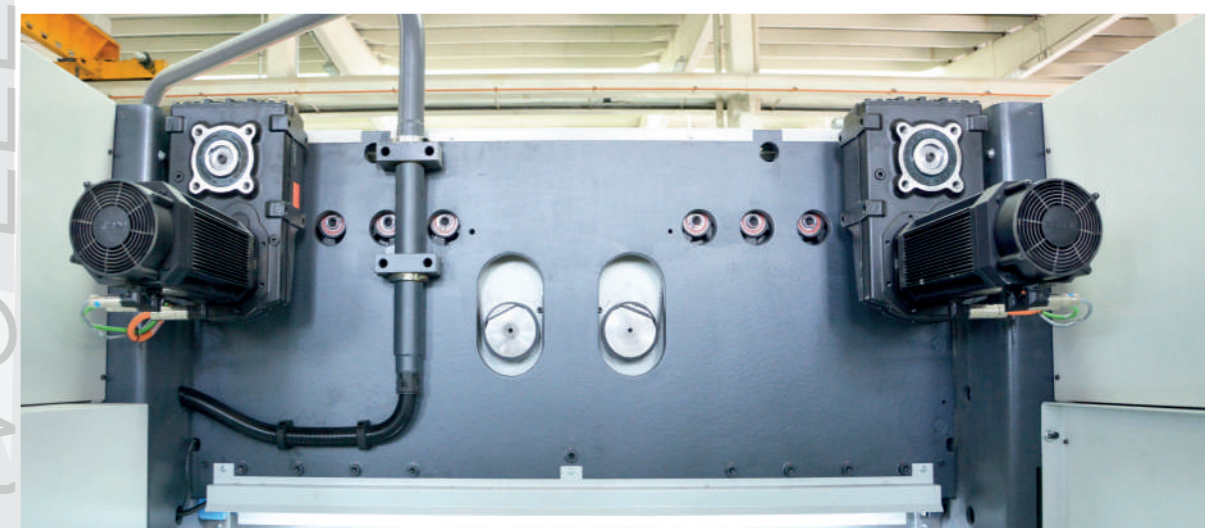

“EXCEED YOUR EXPECTATIONS”

SERVO ELECTRIC PRESS BRAKE

BACK GAUGES

OPTIONAL



X1-X2-R-Z1-Z2
Type Back Gauge

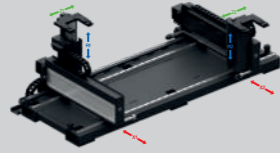

ATF Type 6 Axis
Back Gauge



X1-X2-R-Z1-Z2
Type Back Gauge

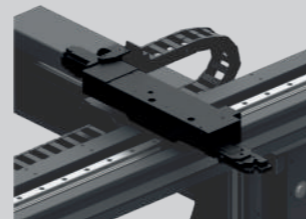

X-Prime Type Back Gauge

Gauging is a main concern for press brake operators. Whether you require complex part multi station bending, single bending, or production of taper bends, Servo Electric Press Brake offers solutions with six different back gauge options. Depending on the geometry of the parts and their complexity, all back gauge models are specially designed and manufactured to reach high precision and high speeds.

Optional Back Gauge Systems

- X1, X2, R
- X, R, Z1, Z2
- X, X', R, Z1, Z2
- X1, X2, R, Z1, Z2
- X1, X2, R1, R2, Z1, Z2 (ATF TYPE)

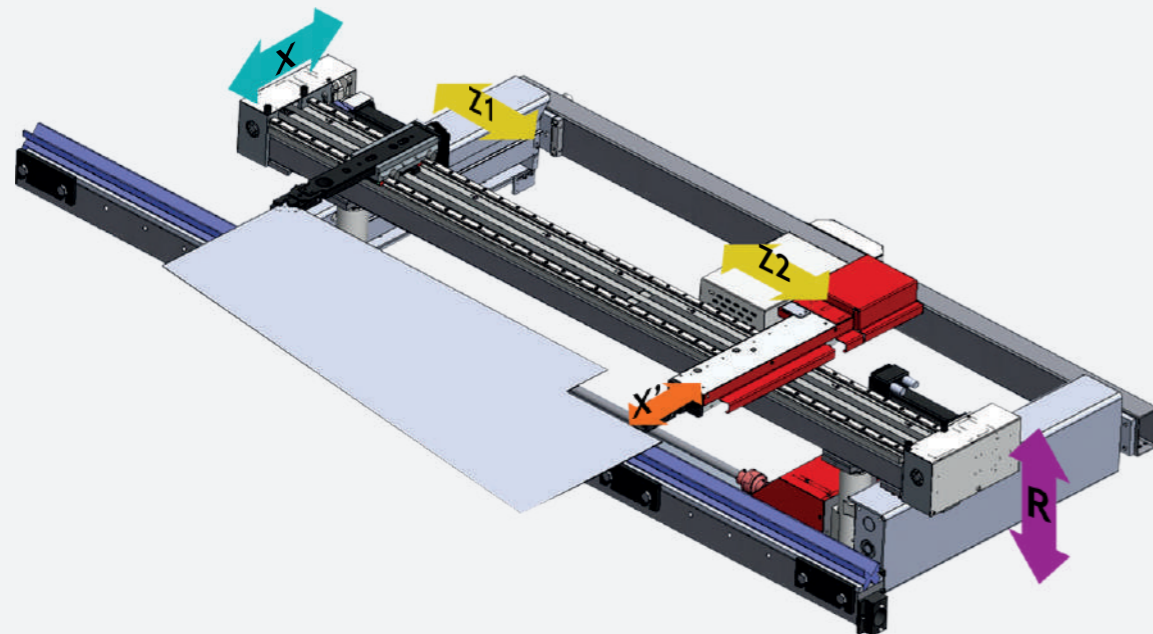

DENER SERVO ELECTRIC PRESS BRAKE BACK GAUGE SPECIFICATIONS

X - R type back gauge (standard) Ball Screw for X axis, double linear guide for X axis. 750 mm X axis stroke, 250 mm R axis stroke 2 Pcs back gauge finger manual lateral movement on linear guides Positioning accuracy: +0,03 mm Repeat accuracy: +0,03

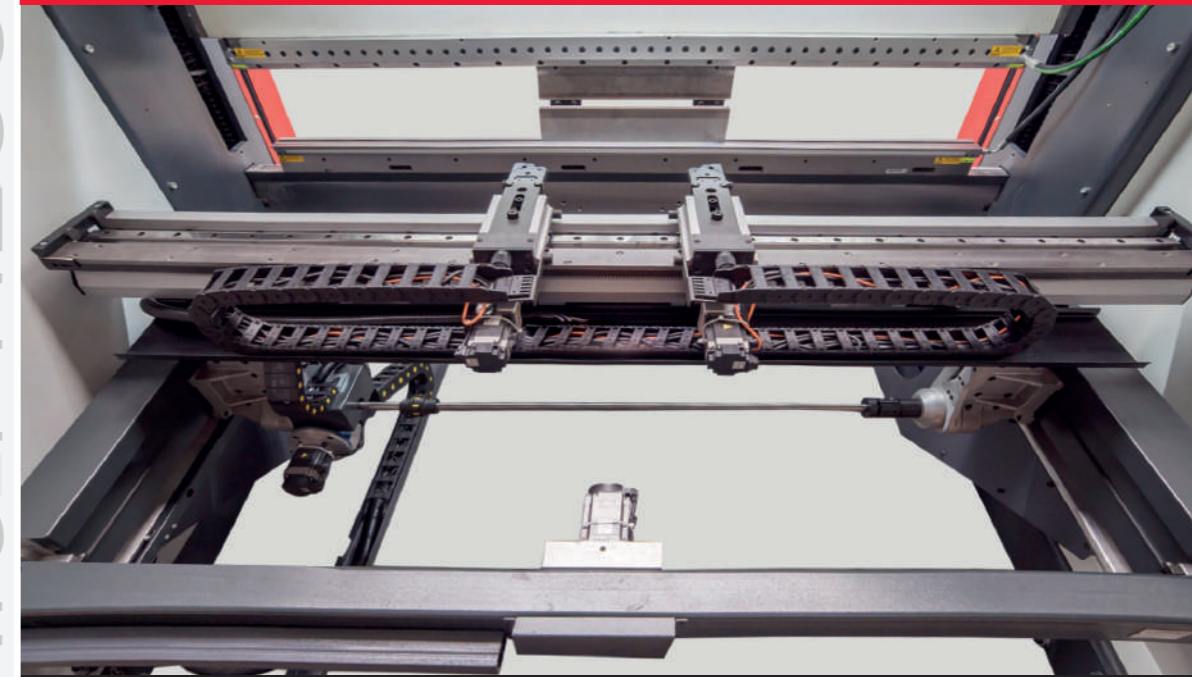

X - R - Z1 - Z2 4 AXIS BACK GAUGE OPTION

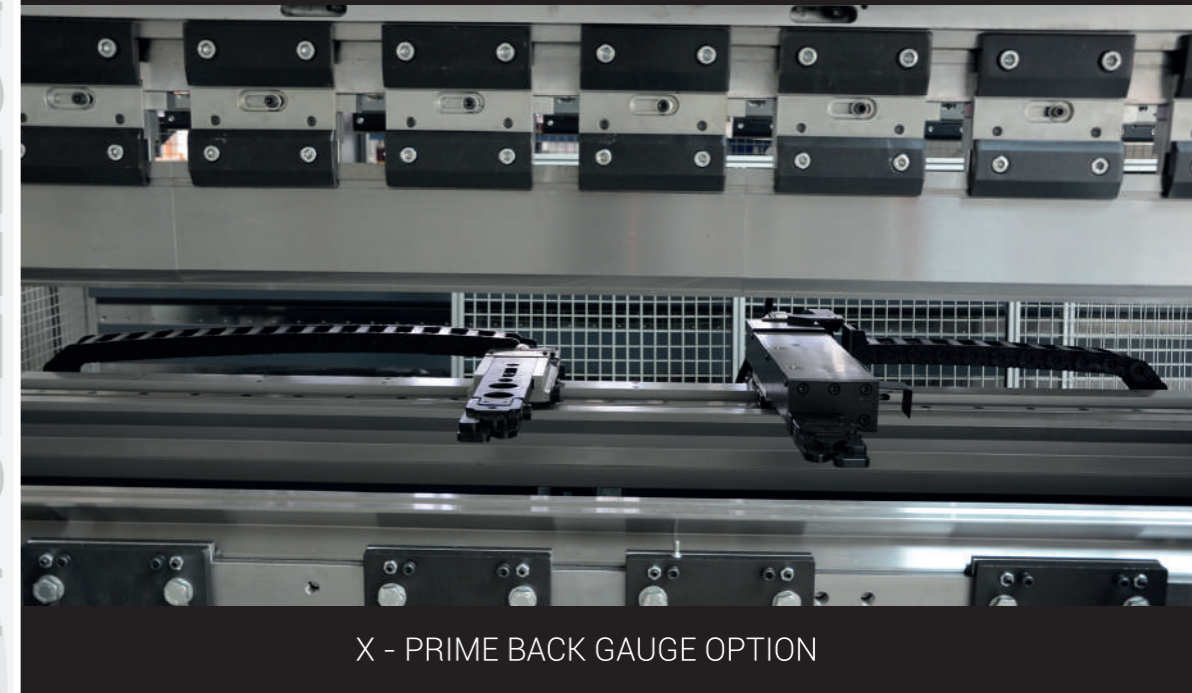

X - PRIME BACK GAUGE OPTION

CONTROLLERS

STANDARD

ESA S 685 W CONTROLLER

3D

- 3D and 2D graphics touch screen programming mode
- 3D and 2D imaging in simulation and production
- 21" high resolution colour touch screen
- Full-featured Windows application
- ESA offline software
- USB flash memory drive
- Hard disk for more than 1.000.000 part programs
- 2D and 3D automatic bending sequence calculation
- Graphical product and tool selection

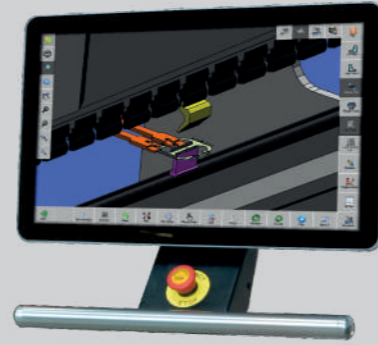

OPTIONAL

DELEM DA-66T

3D

- 2D graphical touch screen programming mode
- 3D visualisation in simulation and production
- 17" high resolution colour TFT
- Full Windows application suite
- Delem modusys compatibility
- USB, peripheral interfacing
- User specific application support with in the controllers
- Multitasking environment
- Sensor bending & correction interface



OPTIONAL

DELEM DA-69T

- 3D and 2D graphical touch screen programming mode
- 3D visualisation in simulation and production
- 17" high resolution colour TFT
- Full Windows application suite
- Delem modusys compatibility
- USB, peripheral interfacing
- User specific application support with in the controllers
- Multitasking environment
- Sensor bending & correction interface

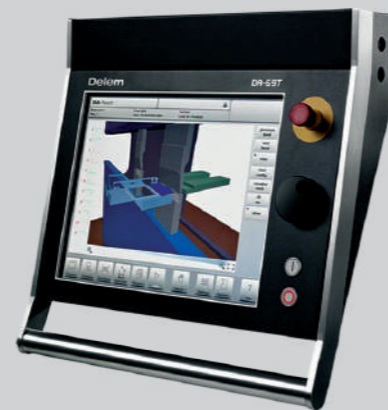

Servo Electric Press Brakes come with advance CNC controllers, fast and accurate punch and die clamping, multi axis back gauge system. Operators simply make perfect sheet metal parts with very low cost.



CLAMPING SYSTEMS

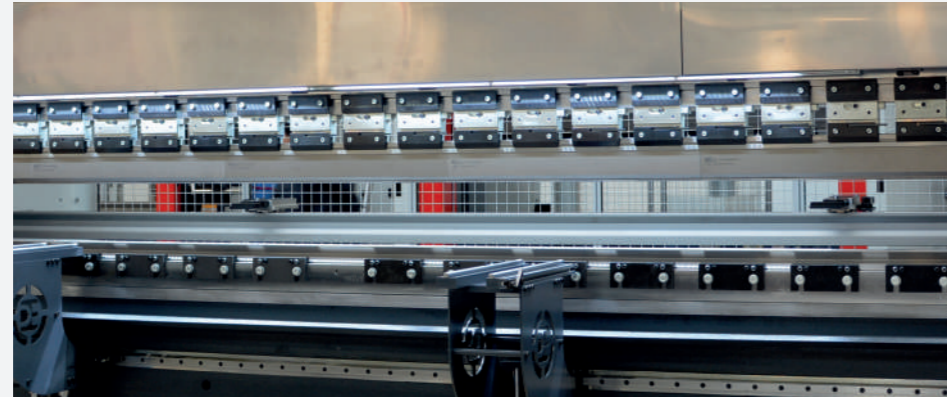

European Type Sectioned Punch Clamping System



European Type Pneumatic Punch Clamping System



Wilson Hydraulic Punch and Die Clamping System

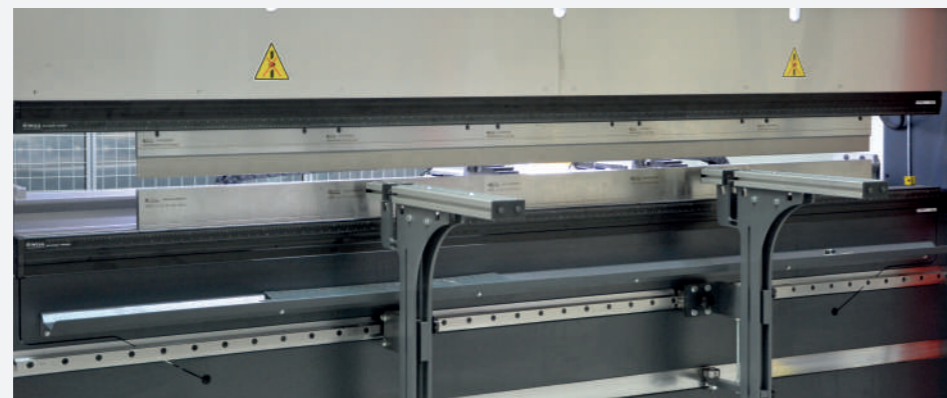

American Type Sectioned Punch Clamping System

OPTIONAL

SERVO ELECTRIC PRESS BRAKE

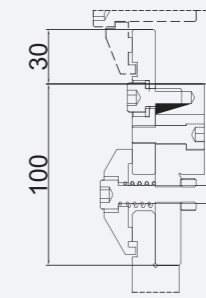

Euro Type Mechanical Punch Clamping

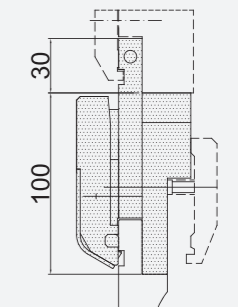

Euro Type Pneumatic Punch Clamping

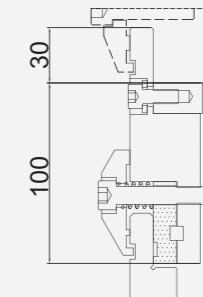

Euro American Type Mechanical Punch Clamping

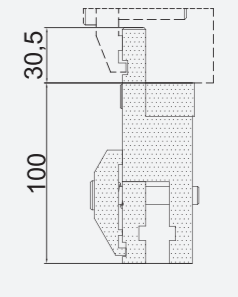

American Type Mechanical Punch Clamping

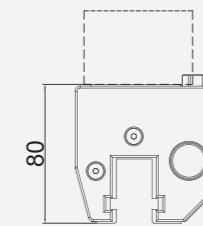

Wilson Hydraulic Automatic Punch Clamping

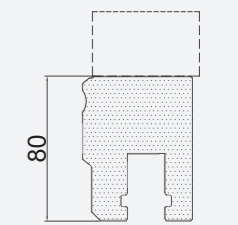

Wilson American Type Mechanical Punch Clamping

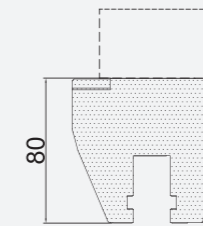

Wila Hydraulic New Standard Automatic Punch Clamping

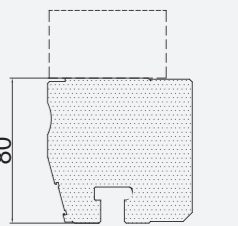

Wila American Type Hydraulic Punch Clamping

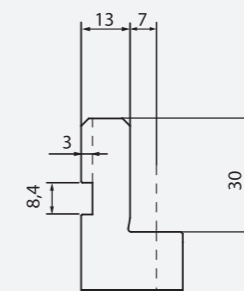

Euro Type Punch

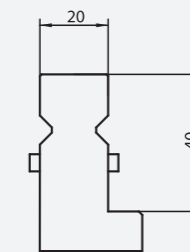

Wila New Standard Punch

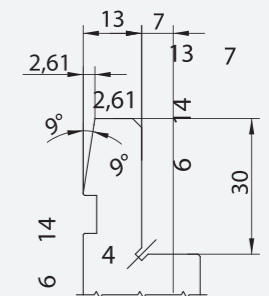

One Touch Punch

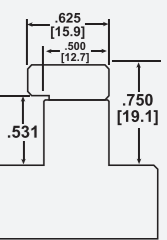

American Style Punch



CLAMPING SYSTEMS

NSCL-I-MC/UPB

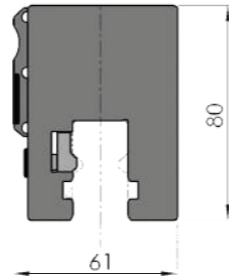
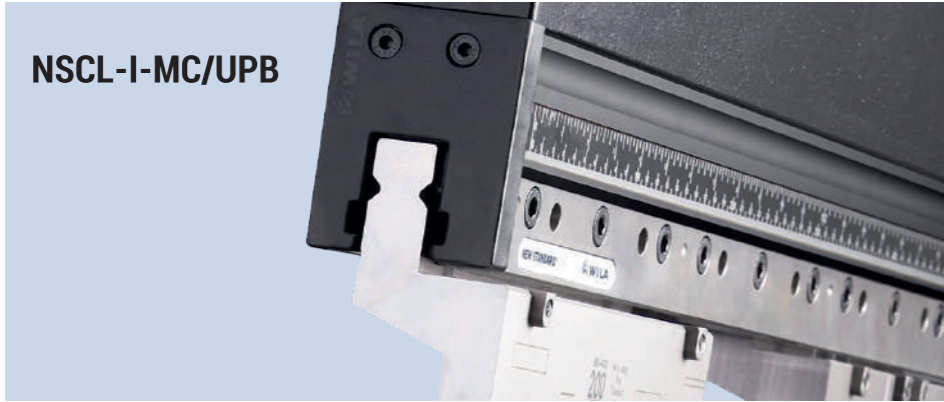

OB-I-MC-TY/ES IV

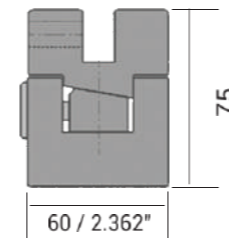

NSCL-I-HC/UPB

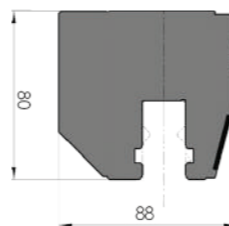

NSCL-I-HC-CNC/UPB

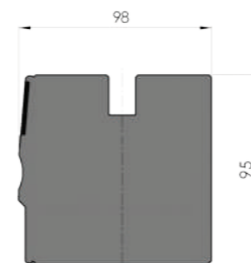

- Extremely fast press brake tooling changes
- Maximum control of vertical tolerances during the bending process
- Extremely accurate clamping, positioning and alignment
- Individual clamping pins for each tool segment for superior clamping force
- Vertical and horizontal tool loading and unloading for maximum speed and safety
- Professional finish, including a slide rule for ease of tool positioning
- Provides maximum productivity



OPTIONAL

SERVO ELECTRIC PRESS BRAKE

AIR BENDING TONNAGE CHART

Required press force at 90° air bending, force in t/m.

The charts below give the appropriate tonnage to air bend mild steel.

Bending force for other metals:

- Soft aluminum : Tons per unit length x 50%
- Aluminum alloys heat treated : Tons per unit length x 100%
- Stainless : Tons per unit length x 150%
- Bottoming : Tonnage requirements are three to five times greater than for air bending.

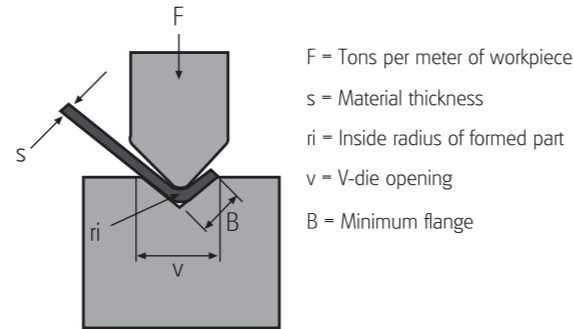

Metric

V (mm)	4	6	8	10	12	16	20	24	30	40	50	60	80	100	120	160
V (inch)	0.157"	0.236"	0.315"	0.394"	0.472"	0.630"	0.787"	0.945"	1.181"	1.575"	1.969"	2.362"	3.150"	3.937"	4.724"	6.299"
B (outside mm)	2.8	4.2	5.6	7	8.6	11.5	14.4	17	21	29	36	42.4	56.5	71	85	114
ri (mm)	0.6	1	1.2	1.5	1.8	2.4	3	3.6	4.5	6	7.5	9	12	15	18	24

Material Thickness mm

0,5	4	2																
1	10	8	5,5	4,5														
1,2	16	12	9	7														
1,5		20	14	11	6													
2				22	15	11	9,5											
2,5					25	19	15	11										
3						28	22	17	12									
4							44	33	22,5	17								
5								55	37	29	22							
6									58	42	34							
8										83	65	45	35					
10											110	75	57	45				
12												116	85	68				
14													121	91	68			
15														143	112	79		
16															168	131	90	
18																172	119	
20																	222	150
25																		254

Inch

V (mm)	6.4	9.5	12.7	15.9	19.05	22.2	25.4	28.6	31.8"	38.1	50.8	63.5	80	100	120	160
V (inch)	0.250"	0.375"	0.500"	0.625"	0.750"	0.875"	1.000"	1.125"	1.250"	1.500"	2.000"	2.500"	3.150"	3.937"	4.724"	6.299"
B (outside inch)	0.167"	0.265"	0.354"	0.442"	0.530"	0.619"	0.707"	0.795"	0.866"	1.06"	1.414"	1.768"	2.224"	2.795"	3.346"	4.488"
ri (inch)	0.038"	0.056"	0.075"	0.094"	0.113"	0.131"	0.150"	0.169"	0.188"	0.225"	0.300"	0.375"	0.472"	0.591"	0.709"	0.945"

Material Thickness Gauge Inches

20	3.2	2.0																
18	5.1	3.4	2.7	2.4														
16		5.8	4.0	3.1	2.5													
14			6.9	5.0	4.0	3.5												
12					8.3	6.9	5.6											
11						9.9	8.2	7.2	5.4									
10							11.9	9.9	7.3	7.1	5.8							
3/16"									14.3	14.2	12.2	7.5						
1/4"											23.7	16.5	11.4					
5/16"												27	19.7					
3/8"													42.3	30.9	22.8	16.9		
7/16"														32.2	24.3	19.4		
1/2"															34.6	27.0	18.3	
5/8"																47.1	32.0	
3/4"																	74.2	50.4
7/8"																		73.9
1"																		103.0

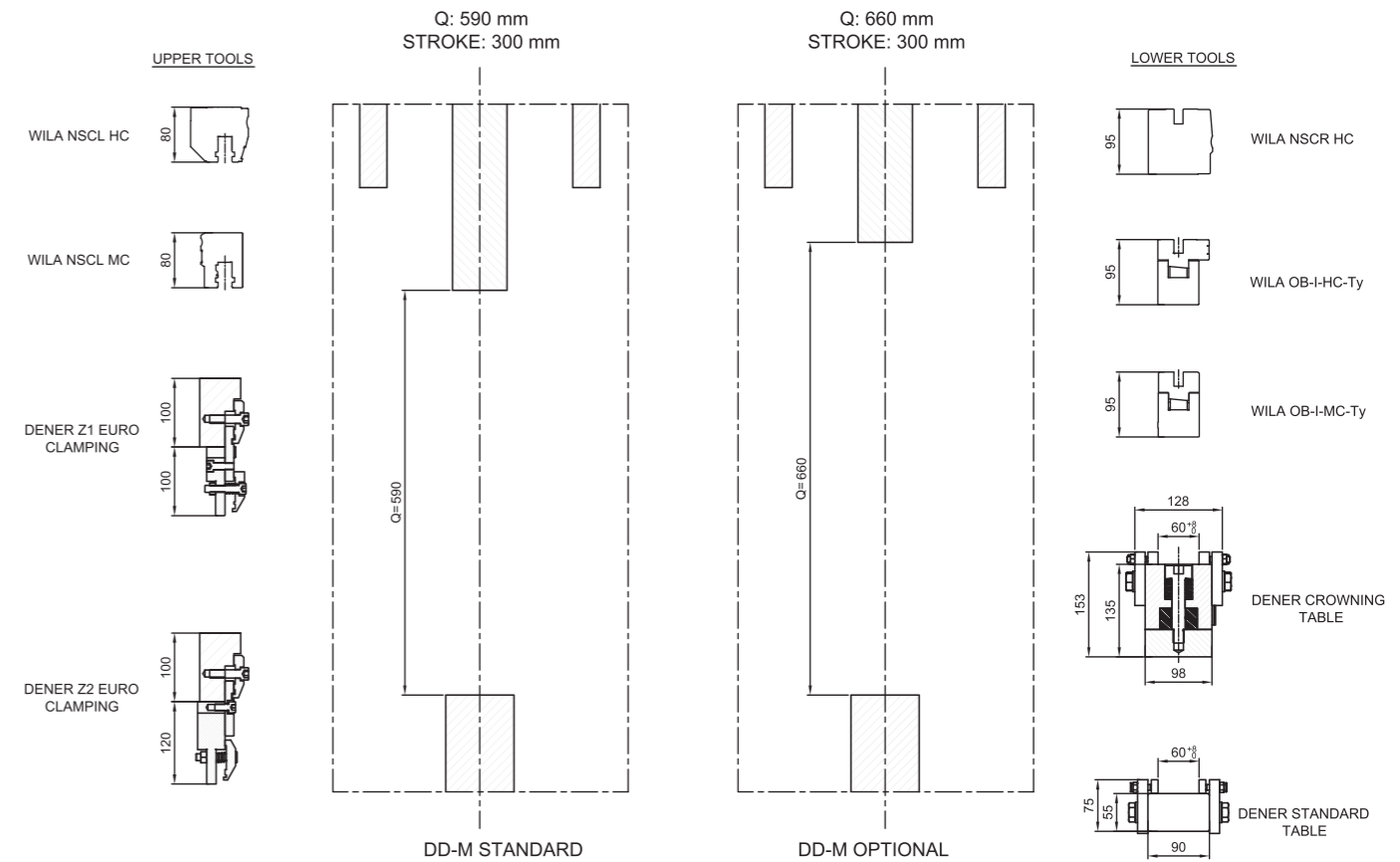

TECHNICAL SPECIFICATIONS

	Bending Length (mm)	Pressure Force (ton)	Max. Stroke (mm)	Q - Distance Between Tables (mm)	Approaching Speed (mm/sec)	Bending Speed (mm/sec)	Return Speed (mm/sec)	Main Motor Power (kw)	Weight (kg)	L - Overall Length (mm)	W - Width (mm)	H - Height (mm)
DD-M-20040	4080	200	300	590	75	20	75	22	14900	5755	2460	2800
DD-M-17535	3570	175	300	590	90	20	90	22	14100	5350	2460	2800
DD-M-15030	3050	150	300	590	100	20	100	22	12700	4750	2460	2800
DD-M-13030	3050	130	300	590	85	20	85	12,5	8400	4220	2330	2630
DD-M-10030	3050	100	300	590	75	20	75	11	6900	4220	2260	2500
DD-M-8025	2550	80	300	590	90	20	90	11	6400	3680	2260	2500
DD-M-6525	2550	65	300	590	130	20	130	11	6200	3680	2260	2500
DD-M-5020	2040	50	300	590	150	20	150	11	5500	3170	2260	2500
DD-M-4015	1530	40	300	590	170	20	170	11	4800	2660	2260	2500

